

F33 TRUSS ISOMETRIC
N.T.S.

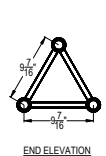

2007-T4 AL CONICAL CONNECTOR (AS-MACHINED)(TYP)

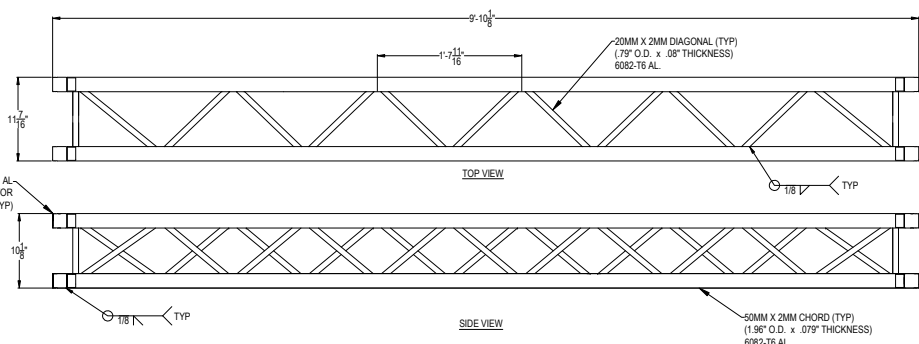

TYPICAL F33 TRUSS

1-1/2" = 1'-0"

NOTES:
GENERAL CONSTRUCTION SHOWN ONLY. LENGTH OF INDIVIDUAL TRUSS UNITS USED IN CONSTRUCTION WILL VARY
SEE MANUFACTURERS WEBSITE FOR ADDITIONAL INFORMATION ON AVAILABLE LENGTHS.
TRUSS IS FABRICATED USING METRIC UNITS. DIMENSIONS ON THESE DRAWINGS ARE ROUNDED TO THE NEAREST 1/16". DO NOT USE THESE DRAWINGS FOR FABRICATION OR REPAIR. DRAWINGS ARE FOR GENERAL DESCRIPTION AND ALLOWABLE LOADING ONLY.

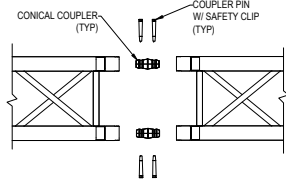

TRUSS TO TRUSS CONNECTION
1-1/2" = 1'-0"

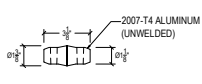

CONICAL COUPLER
3" = 1'-0"

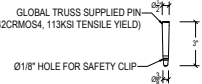

COUPLER PIN
3" = 1'-0"

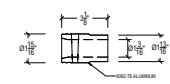

CONICAL ADAPTER
3" = 1'-0"

GENERAL NOTES

- REFERENCED CODES**
- 2018 INTERNATIONAL BUILDING CODE
 - ANSI E1.21 2020 "ENTERTAINMENT TECHNOLOGY - DESIGN, MANUFACTURE AND USE OF ALUMINUM TRUSSES AND TOWERS"
 - ADM 2015 "SPECIFICATION FOR ALUMINUM STRUCTURES"
 - AISC 360-16 "SPECIFICATION FOR STRUCTURAL STEEL BUILDINGS"
- ALUMINUM TRUSS**
- FABRICATION AND ERECTION OF STRUCTURAL ALUMINUM SHALL CONFORM TO THE ALUMINUM DESIGN MANUAL - 2015
 - STRUCTURAL ALUMINUM SHALL BE ALLOY 6082-T6 (U.N.O.)
 - ALL WELD FILLER SHALL BE 5356 (U.N.O.)
 - ALL WELDING MUST CONFORM TO AWS D12
 - TAPERED PINS SUPPLIED BY GLOBAL TRUSS MUST BE USED IN INSTALLATION
 - WHERE THE CONTACT OF DISSIMILAR METALS MAY CAUSE CORROSION, THE CONTACT SURFACE OF EITHER METAL MUST BE PROPERLY COATED TO PREVENT THE EFFECT.

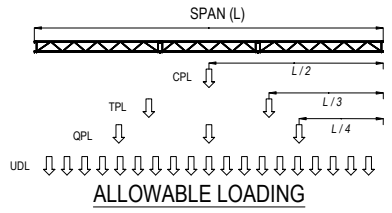

- NOTES:
- ALL LOADS MUST BE ATTACHED TO TRUSS PANEL POINTS
 - BRIDLES ARE NOT PERMITTED UNLESS APPROVED IN WRITING BY A LICENSED STRUCTURAL ENGINEER.
 - SELF WEIGHT OF THE TRUSS HAS BEEN INCLUDED IN THE ALLOWABLE LOADING TABLES. NO REDUCTION IS REQUIRED TO ACCOUNT FOR THE TRUSS ITSELF.
 - NO SHOCK OR DYNAMIC FORCES HAVE BEEN INCLUDED IN THE ALLOWABLE LOADING.
 - UNIFORMLY DISTRIBUTED LOADS APPLY ONLY TO LOADS EVENLY DISTRIBUTED ACROSS THE ENTIRE SPAN
 - LOADS SEEN IN THE TABLE ARE NOT ADDITIVE.
 - THE ALLOWABLE LOADING TABLES HAVE BEEN PROVIDED FOR GENERAL REFERENCE ONLY AND ALL RIGGING PLOTS SHOULD BE REVIEWED BY A LICENSED STRUCTURAL ENGINEER.
 - LOAD TABLES APPLY TO TRUSS ORIENTATED APEX UP OR DOWN

GLOBAL TRUSS F33 LOAD SPAN TABLE
Limited based on Strength and L/180 Deflections

TRUSS SPAN	UNIFORMLY DISTRIBUTED LOAD (UDL)		CENTER POINT LOAD (CPL)		THIRD POINT LOADS (TPL)		QUARTER POINT LOADS (QPL)		
	METERS	FEET	LOAD (PLF)	DEFLECTION (IN)	LOAD (LBS)	DEFLECTION (IN)	LOAD (LBS)	DEFLECTION (IN)	
2	6.56	285	0.12	1500	0.17	850	0.11	600	0.15
2.5	8.2	243	0.22	1325	0.25	775	0.21	555	0.25
3	9.84	201	0.33	1150	0.32	700	0.30	505	0.35
3.5	11.48	169	0.43	975	0.39	625	0.40	460	0.45
4	13.12	117	0.54	800	0.47	550	0.49	410	0.55
4.5	14.76	101	0.65	730	0.55	505	0.54	375	0.7
5	16.41	85	0.84	660	0.71	455	0.80	340	0.85
5.5	18.05	88	0.99	590	0.83	410	0.95	305	1.0
6	19.69	52	1.14	520	0.96	360	1.10	270	1.15
6.5	21.33	46	1.34	490	1.15	330	1.33	245	1.30
7	22.97	38	1.55	460	1.35	300	1.55	220	1.45
7.5	24.61	31	1.76	430	1.55	265	1.78	195	1.60
8	26.25	24	1.95	400	1.75	235	1.75	170	1.75
8.5	27.89	21	1.96	360	1.86	210	1.86	155	1.86
9	29.53	18	1.97	315	1.97	190	1.97	135	1.97
9.5	31.17	15	2.08	275	2.08	165	2.08	120	2.08
10	32.81	12	2.19	230	2.19	140	2.19	100	2.19
10.5	34.45	10	2.30	205	2.30	125	2.30	90	2.30
11	36.09	9	2.41	185	2.41	110	2.41	80	2.41
11.5	37.73	7	2.52	160	2.52	95	2.52	70	2.52
12	39.37	6	2.63	135	2.63	80	2.63	60	2.63

GLOBAL TRUSS F33 LOAD SPAN TABLE
Limited based on Strength Only (No Deflection Limits)

TRUSS SPAN	UNIFORMLY DISTRIBUTED LOAD (UDL)		CENTER POINT LOAD (CPL)		THIRD POINT LOADS (TPL)		QUARTER POINT LOADS (QPL)		
	METERS	FEET	LOAD (PLF)	DEFLECTION (IN)	LOAD (LBS)	DEFLECTION (IN)	LOAD (LBS)	DEFLECTION (IN)	
2	6.56	285	0.12	1500	0.17	850	0.11	600	0.15
2.5	8.2	243	0.22	1325	0.25	775	0.21	555	0.25
3	9.84	201	0.33	1150	0.32	700	0.30	505	0.35
3.5	11.48	169	0.43	975	0.39	625	0.40	460	0.45
4	13.12	117	0.54	800	0.47	550	0.49	410	0.55
4.5	14.76	101	0.65	730	0.55	505	0.54	375	0.7
5	16.41	85	0.84	660	0.71	455	0.80	340	0.85
5.5	18.05	88	0.99	590	0.83	410	0.95	305	1.0
6	19.69	52	1.14	520	0.96	360	1.10	270	1.15
6.5	21.33	46	1.34	490	1.15	340	1.33	250	1.35
7	22.97	40	1.55	460	1.35	315	1.55	230	1.54
7.5	24.61	34	1.76	430	1.55	285	1.78	210	1.74
8	26.25	28	1.96	400	1.75	270	2.01	190	1.94
8.5	27.89	25	2.23	375	1.96	250	2.26	180	2.20
9	29.53	23	2.60	340	2.19	240	2.52	170	2.47
9.5	31.17	20	2.76	320	2.30	225	2.78	165	2.74
10	32.81	17	3.03	290	2.41	210	3.04	145	3.00
10.5	34.45	16	3.35	275	2.91	200	3.37	135	3.01
11	36.09	14	3.67	260	3.22	185	3.70	130	3.61
11.5	37.73	13	3.98	245	3.52	175	4.03	120	3.90
12	39.37	11	4.30	230	3.83	160	4.36	110	4.22

GLOBAL TRUSS F33 LOAD SPAN TABLE
Limited based on Strength and Reduced per ANSI E1.21

TRUSS SPAN	UNIFORMLY DISTRIBUTED LOAD (UDL)		CENTER POINT LOAD (CPL)		THIRD POINT LOADS (TPL)		QUARTER POINT LOADS (QPL)		
	METERS	FEET	LOAD (PLF)	DEFLECTION (IN)	LOAD (LBS)	DEFLECTION (IN)	LOAD (LBS)	DEFLECTION (IN)	
2	6.56	242	0.10	1275	0.15	725	0.10	510	0.13
2.5	8.2	207	0.19	1125	0.21	660	0.18	470	0.21
3	9.84	171	0.28	980	0.27	595	0.26	430	0.30
3.5	11.48	136	0.37	830	0.34	530	0.34	390	0.38
4	13.12	99	0.46	680	0.43	470	0.42	350	0.47
4.5	14.76	85	0.58	620	0.50	430	0.55	320	0.60
5	16.41	72	0.71	560	0.61	390	0.68	290	0.72
5.5	18.05	58	0.84	500	0.71	345	0.81	260	0.85
6	19.69	44	0.97	440	0.81	305	0.94	230	0.98
6.5	21.33	39	1.14	400	0.98	285	1.13	215	1.14
7	22.97	34	1.32	360	1.15	270	1.32	195	1.31
7.5	24.61	29	1.49	365	1.32	250	1.51	180	1.48
8	26.25	24	1.67	340	1.46	230	1.70	160	1.65
8.5	27.89	21	1.89	315	1.67	215	1.82	150	1.87
9	29.53	19	2.12	295	1.85	205	2.14	140	2.10
9.5	31.17	17	2.35	270	2.03	190	2.36	135	2.33
10	32.81	14	2.58	245	2.22	180	2.58	125	2.55
10.5	34.45	13	2.85	225	2.48	170	2.85	115	2.81
11	36.09	12	3.12	220	2.74	165	3.14	110	3.07
11.5	37.73	11	3.39	210	2.99	145	3.43	100	3.33
12	39.37	9	3.66	195	3.25	135	3.71	95	3.59

Project Name: **F33 Truss Load Span Tables**
Event/Venue Name and Address: **General Use**

ISSUE/REVISIONS

REV	DESCRIPTION

Sheet Name: **F33 Load Span Tables**
Project No.: **S1.0**
Date: **01/26/2020**